

TIGERGRIP | TG 35S

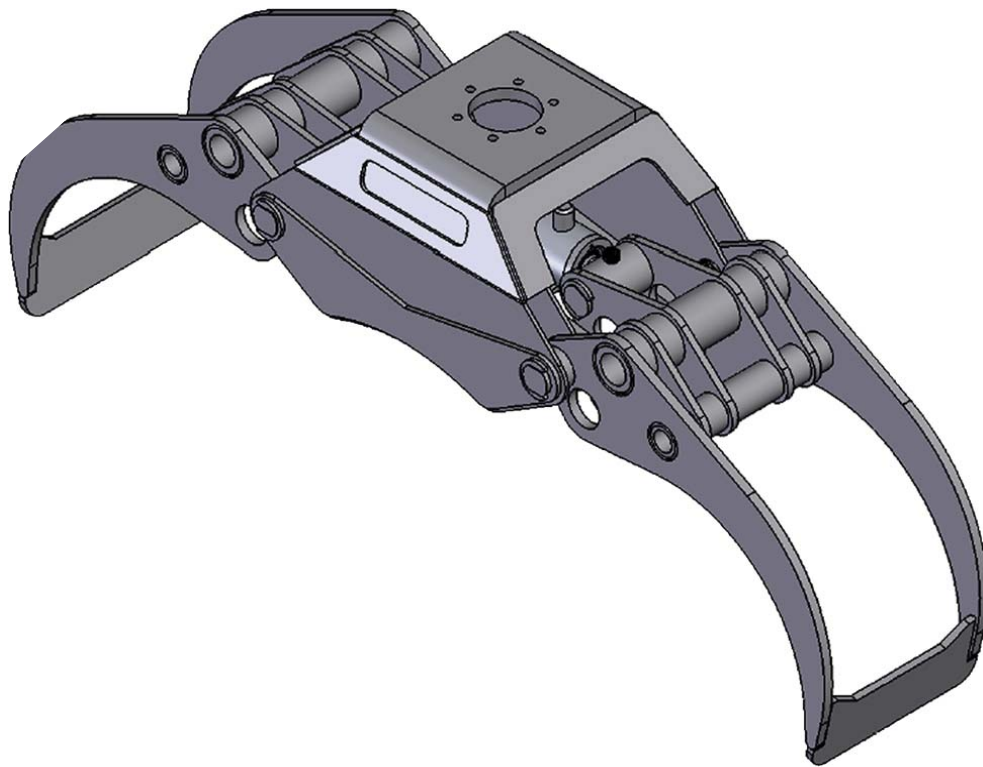

KEY FEATURES

- Heavy duty
- Double guide bars
- Optimized roll in/roll out properties
- High pressure cylinder with double piston rod seals
- High tensile wear resistant steel (400 HB)
- Extra reinforced body for rigid mounting - excavator design

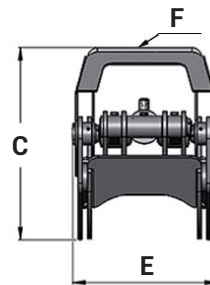
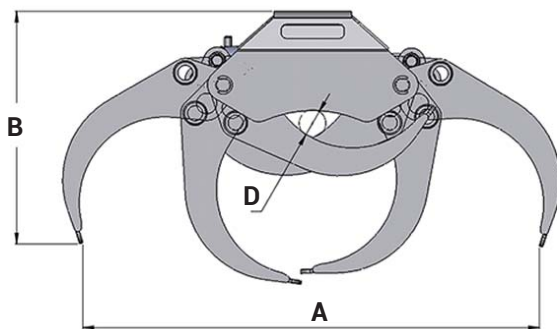

A	1870
B	808
C	590
D	65
E	522
F	173/6

MODEL SPECIFICATIONS



TG 35S	310	0,38	300	60	17,5	15	7	15	12	OK		
--------	-----	------	-----	----	------	----	---	----	----	----	--	--

INTERMERCATO

High performance lift and load attachments for Forestry, Transport, Construction and Recycling.

